

Article number: 208060361

Description: E+G Sphericalwasher female DIN 6319-42-D-NI  
Stainless Steel 1.4305

## Measures

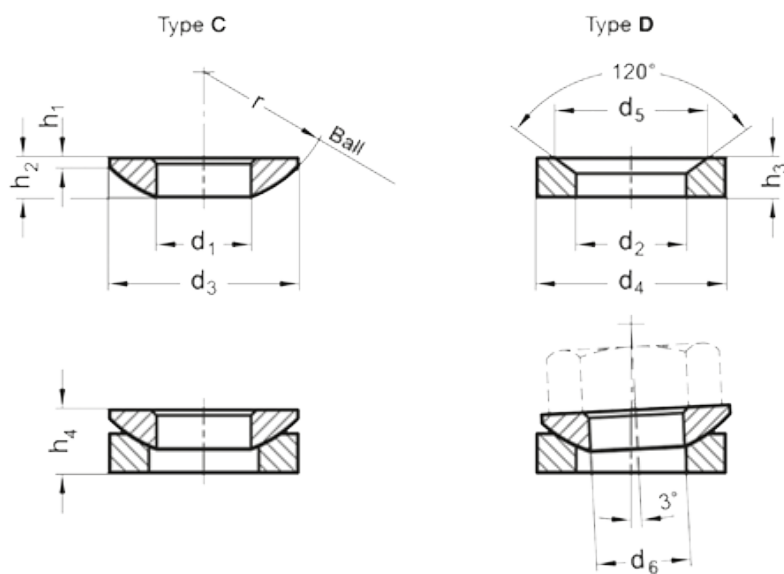

$d_2 = 42.0$

$d_4 = 68$

$d_5 = 60.0$

$d_6 = M36$

$H_3 = 15.0$

$H_4 = 23.5$